



### General Features

- High power and current handling capability
- Lead free product is acquired
- Surface mount package

### Application

- PWM applications
- Load switch
- Power management

### Product Summary

#### ● N-Channel

$V_{DS}$		30	V
$R_{DS(on),Typ}$	$V_{GS}=10V$	22	$m\Omega$
$R_{DS(on),Typ}$	$V_{GS}=4.5V$	30	$m\Omega$
$I_D$		8	A

#### ● P-Channel

$V_{DS}$		-30	V
$R_{DS(on),Typ}$	$V_{GS}=-10V$	43	$m\Omega$
$R_{DS(on),Typ}$	$V_{GS}=-4.5V$	56	$m\Omega$
$I_D$		-6	A

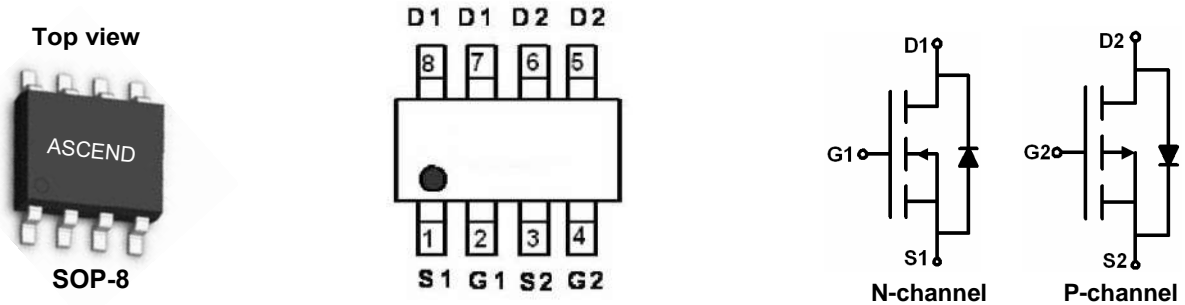

### Absolute Maximum Ratings ( $T_A=25^\circ C$ unless otherwise noted)

Parameter	Symbol	N-Channel	P-Channel	Unit
Drain-Source Voltage	$V_{DS}$	30	-30	V
Gate-Source Voltage	$V_{GS}$	$\pm 20$	$\pm 20$	V
Continuous Drain Current	$I_D$	8	-6	A
Pulsed Drain Current (Note 1)	$I_{DM}$	25	-20	A
Maximum Power Dissipation	$P_D$	2.5	2.5	W
Operating Junction and Storage Temperature Range	$T_J, T_{STG}$	-55 To 150	-55 To 150	$^\circ C$

### Thermal Characteristic

Thermal Resistance, Junction-to-Ambient (Note2)	$R_{\theta JA}$	N-Ch	89	$^\circ C/W$
		P-Ch	90	

**N-CH Electrical Characteristics (T<sub>A</sub>=25°C unless otherwise noted)**

Parameter	Symbol	Condition	Min	Typ	Max	Unit
<b>Off Characteristics</b>						
Drain-Source Breakdown Voltage	BV <sub>DSS</sub>	V <sub>GS</sub> =0V I <sub>D</sub> =250μA	30	-	-	V
Zero Gate Voltage Drain Current	I <sub>DSS</sub>	V <sub>DS</sub> =24V, V <sub>GS</sub> =0V	-	-	1	μA
Gate-Body Leakage Current	I <sub>GSS</sub>	V <sub>GS</sub> =±20V, V <sub>DS</sub> =0V	-	-	±100	nA
<b>On Characteristics (Note 3)</b>						
Gate Threshold Voltage	V <sub>GS(th)</sub>	V <sub>DS</sub> =V <sub>GS</sub> , I <sub>D</sub> =250μA	1	1.5	2.5	V
Drain-Source On-State Resistance	R <sub>DS(ON)</sub>	V <sub>GS</sub> =10V, I <sub>D</sub> =6A	-	22	29	mΩ
		V <sub>GS</sub> =4.5V, I <sub>D</sub> =4A	-	30	43	mΩ
Forward Transconductance	g <sub>FS</sub>	V <sub>DS</sub> =5V, I <sub>D</sub> =5A	-	15	-	S
<b>Dynamic Characteristics (Note4)</b>						
Input Capacitance	C <sub>iss</sub>	V <sub>DS</sub> =15V, V <sub>GS</sub> =0V, F=1.0MHz	-	480	-	PF
Output Capacitance	C <sub>oss</sub>		-	80	-	PF
Reverse Transfer Capacitance	C <sub>rss</sub>		-	60	-	PF
<b>Switching Characteristics (Note 4)</b>						
Turn-on Delay Time	t <sub>d(on)</sub>	V <sub>DD</sub> =15V, R <sub>L</sub> =3Ω V <sub>GS</sub> =10V, R <sub>GEN</sub> =3Ω	-	4.5	-	nS
Turn-on Rise Time	t <sub>r</sub>		-	2.5	-	nS
Turn-Off Delay Time	t <sub>d(off)</sub>		-	14.5	-	nS
Turn-Off Fall Time	t <sub>f</sub>		-	3.5	-	nS
Total Gate Charge	Q <sub>g</sub>	V <sub>DS</sub> =15V, I <sub>D</sub> =5A, V <sub>GS</sub> =10V	-	5.2	-	nC
Gate-Source Charge	Q <sub>gs</sub>		-	0.85	-	nC
Gate-Drain Charge	Q <sub>gd</sub>		-	1.3	-	nC
<b>Drain-Source Diode Characteristics</b>						
Diode Forward Voltage (Note 3)	V <sub>SD</sub>	V <sub>GS</sub> =0V, I <sub>S</sub> =3A	-	-	1.3	V
Diode Forward Current (Note 2)	I <sub>S</sub>		-	-	4	A

**P-CH Electrical Characteristics (T<sub>A</sub>=25°C unless otherwise noted)**

Parameter	Symbol	Condition	Min	Typ	Max	Unit
<b>Off Characteristics</b>						
Drain-Source Breakdown Voltage	BV <sub>DSS</sub>	V <sub>GS</sub> =0V I <sub>D</sub> =-250μA	-30	-	-	V
Zero Gate Voltage Drain Current	I <sub>DSS</sub>	V <sub>DS</sub> =-24V, V <sub>GS</sub> =0V	-	-	-1	μA
Gate-Body Leakage Current	I <sub>GSS</sub>	V <sub>GS</sub> =±20V, V <sub>DS</sub> =0V	-	-	±100	nA
<b>On Characteristics (Note 3)</b>						
Gate Threshold Voltage	V <sub>GS(th)</sub>	V <sub>DS</sub> =V <sub>GS</sub> , I <sub>D</sub> =-250μA	-1	-1.5	-2.5	V
Drain-Source On-State Resistance	R <sub>DS(ON)</sub>	V <sub>GS</sub> =-10V, I <sub>D</sub> =-5A	-	43	52	mΩ
		V <sub>GS</sub> =-4.5V, I <sub>D</sub> =-4A	-	56	77	mΩ
Forward Transconductance	g <sub>FS</sub>	V <sub>DS</sub> =-5V, I <sub>D</sub> =-4.1A	5.5	-	-	S
<b>Dynamic Characteristics (Note4)</b>						
Input Capacitance	C <sub>iss</sub>	V <sub>DS</sub> =-15V, V <sub>GS</sub> =0V, F=1.0MHz	-	648	-	PF
Output Capacitance	C <sub>oss</sub>		-	108	-	PF
Reverse Transfer Capacitance	C <sub>rss</sub>		-	68	-	PF
<b>Switching Characteristics (Note 4)</b>						
Turn-on Delay Time	t <sub>d(on)</sub>	V <sub>DD</sub> =-15V, R <sub>L</sub> =3.6Ω V <sub>GS</sub> =-10V, R <sub>GEN</sub> =3Ω	-	9	-	nS
Turn-on Rise Time	t <sub>r</sub>		-	5	-	nS
Turn-Off Delay Time	t <sub>d(off)</sub>		-	28	-	nS
Turn-Off Fall Time	t <sub>f</sub>		-	13.5	-	nS
Total Gate Charge	Q <sub>g</sub>	V <sub>DS</sub> =-15V, I <sub>D</sub> =-4A, V <sub>GS</sub> =-10V	-	14	-	nC
Gate-Source Charge	Q <sub>gs</sub>		-	3.1	-	nC
Gate-Drain Charge	Q <sub>gd</sub>		-	3.	-	nC
<b>Drain-Source Diode Characteristics</b>						
Diode Forward Voltage (Note 3)	V <sub>SD</sub>	V <sub>GS</sub> =0V, I <sub>S</sub> =-1A	-	-	-1.3	V

**Notes:**

1. Repetitive Rating: Pulse width limited by maximum junction temperature.
2. Surface Mounted on FR4 Board, t ≤ 10 sec.
3. Pulse Test: Pulse Width ≤ 300μs, Duty Cycle ≤ 2%.
4. Guaranteed by design, not subject to production

**N- Channel Typical Electrical and Thermal Characteristics (Curves)**

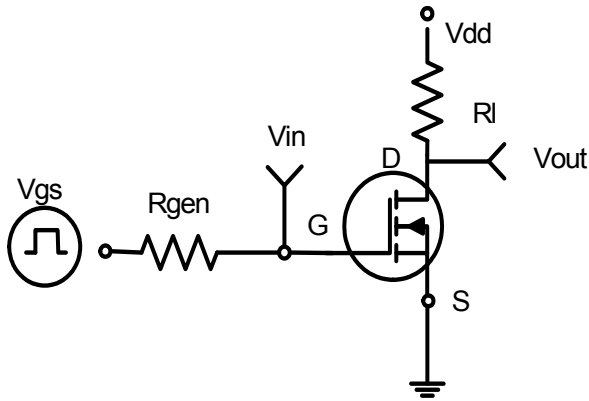

**Figure 1: Switching Test Circuit**

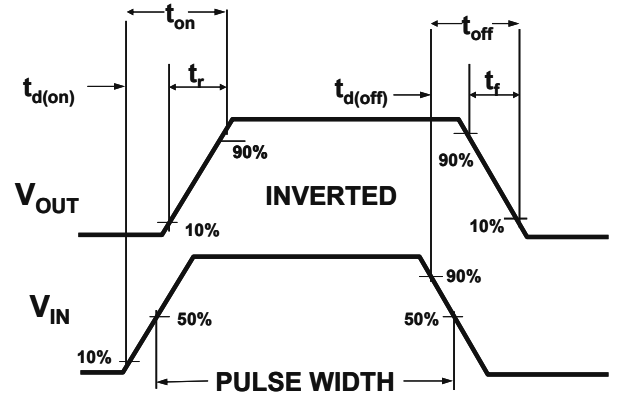

**Figure 2: Switching Waveforms**

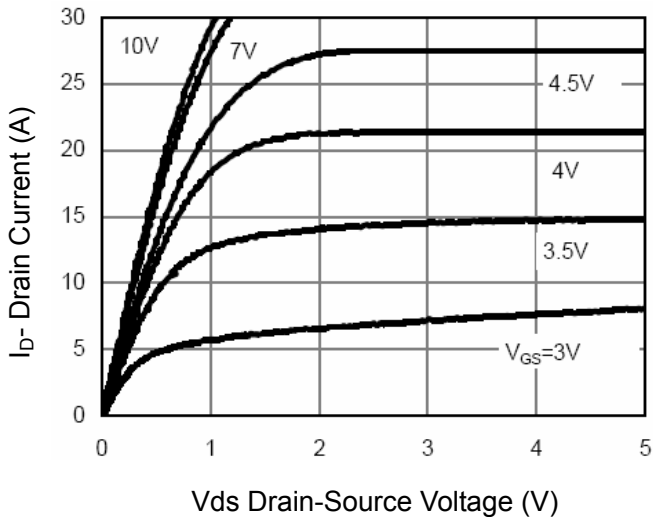

**Figure 3 Output Characteristics**

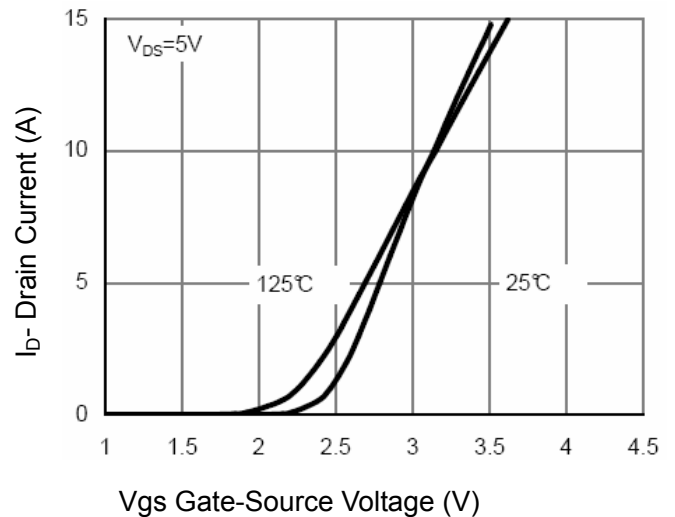

**Figure 4 Transfer Characteristics**

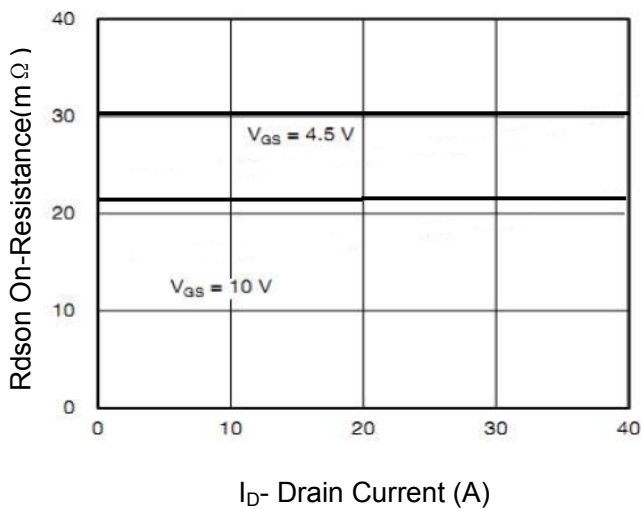

**Figure 5 Drain-Source On-Resistance**

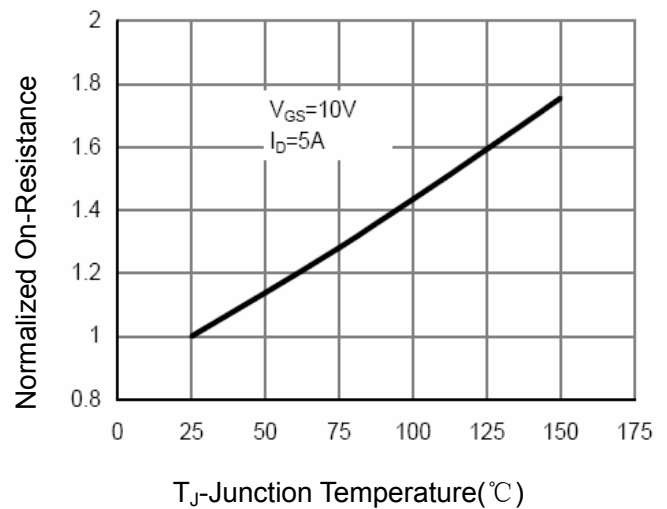

**Figure 6 Drain-Source On-Resistance**

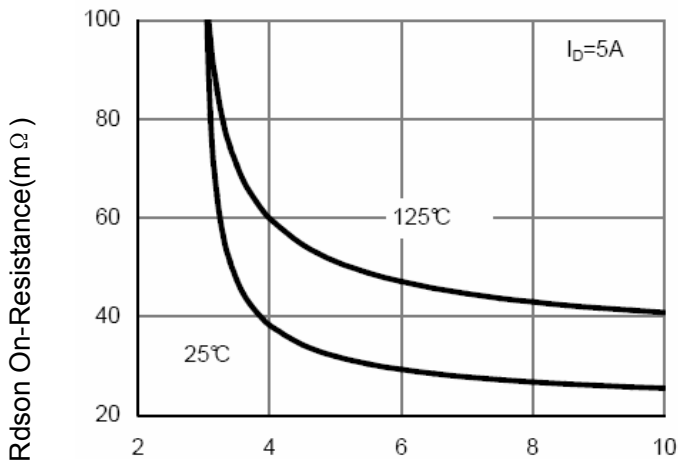

**Figure 7 Rdson vs Vgs**

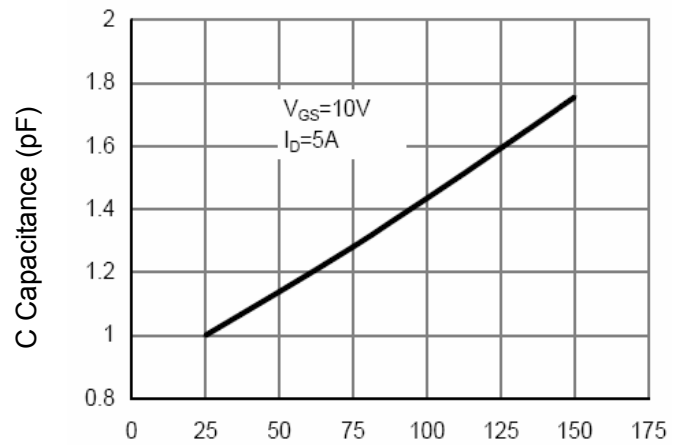

**Figure 8 Drain-Source On-Resistance**

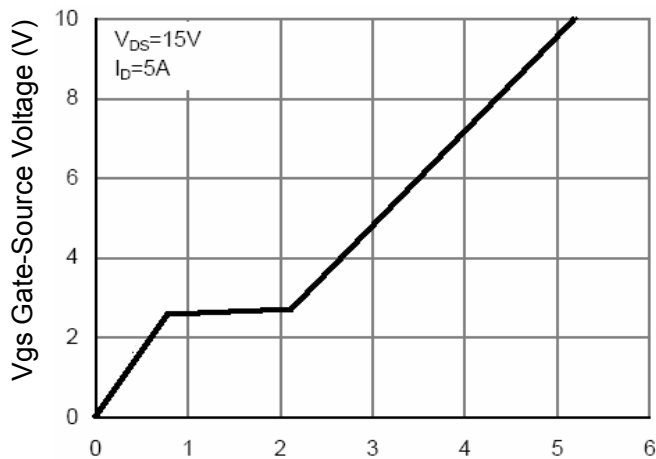

**Figure 9 Gate Charge**

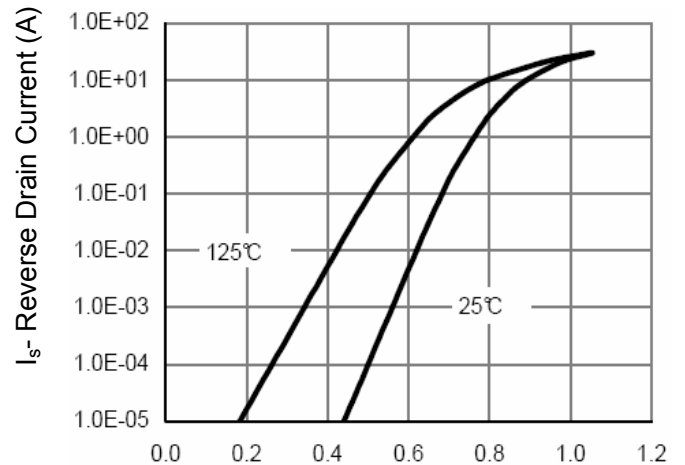

**Figure 10 Source- Drain Diode Forward**

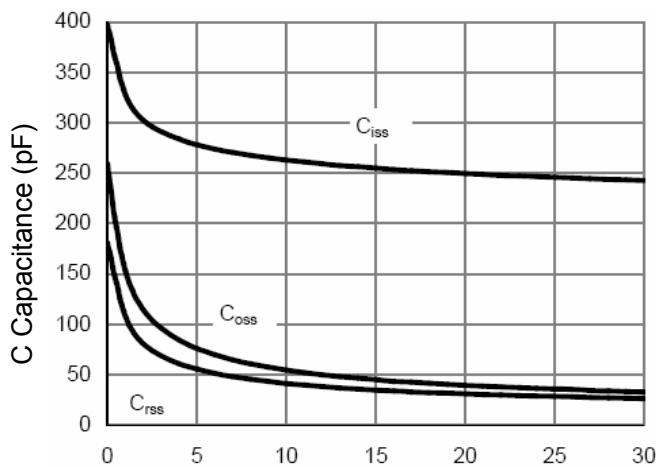

**Figure 11 Capacitance vs Vds**

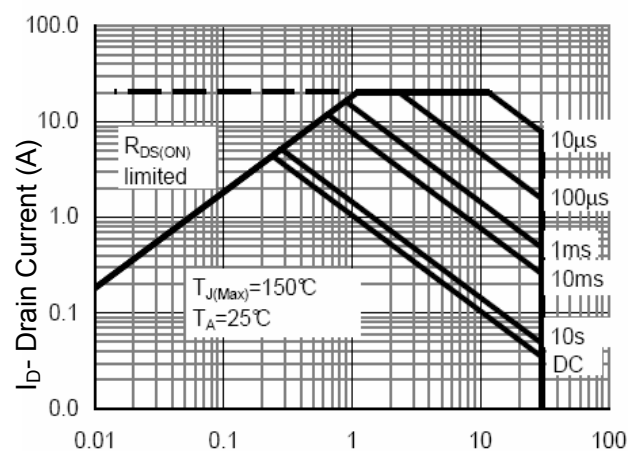

**Figure 12 Safe Operation Area**

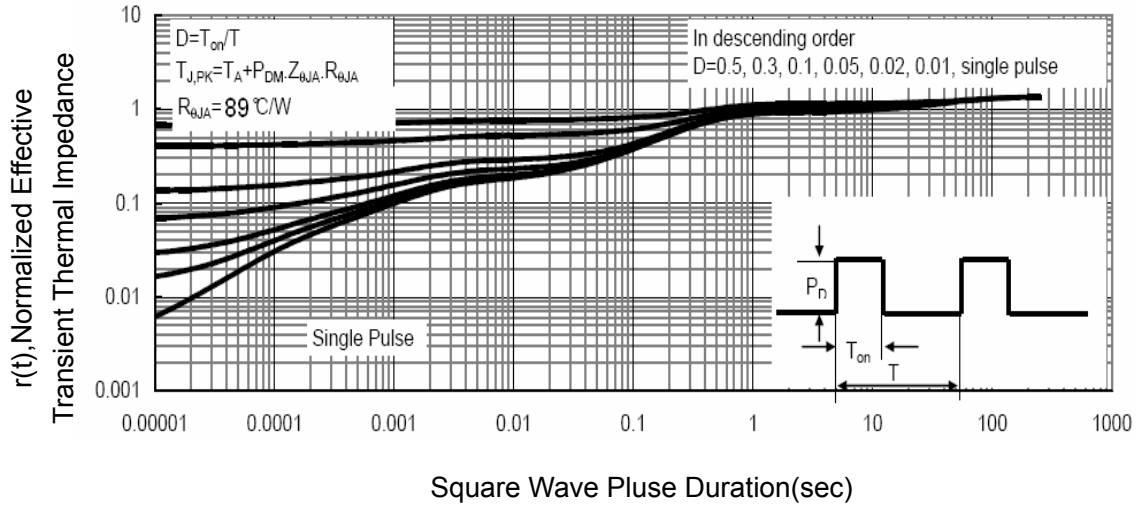

Figure 13 Normalized Maximum Transient Thermal Impedance

P-Channel Typical Electrical and Thermal Characteristics

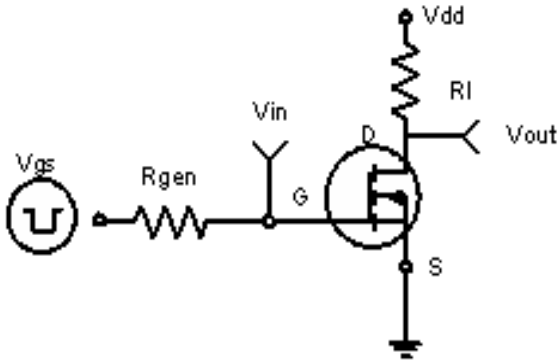

Figure 1: Switching Test Circuit

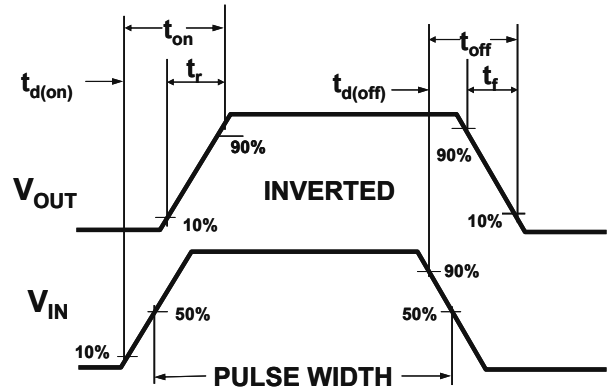
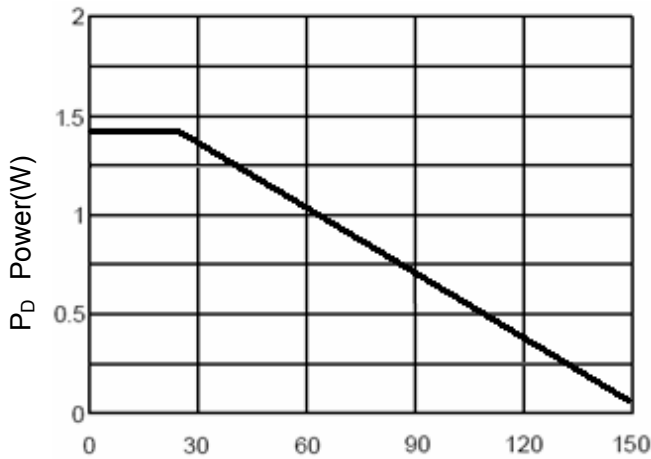
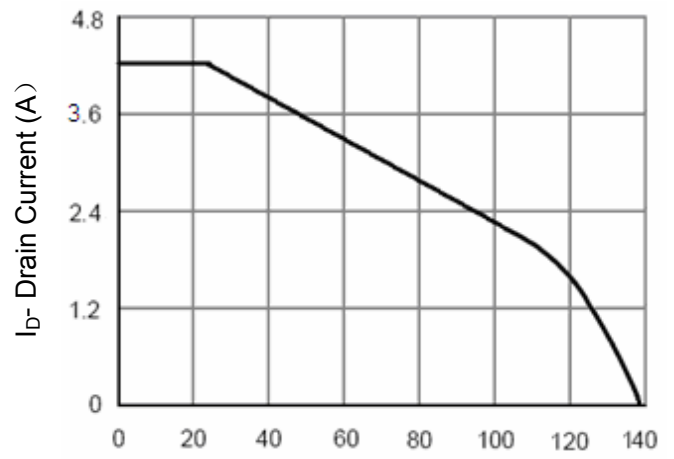

Figure 2: Switching Waveforms



T<sub>J</sub>-Junction Temperature(°C)  
Figure 3 Power Dissipation



T<sub>J</sub>-Junction Temperature(°C)  
Figure 4 Drain Current

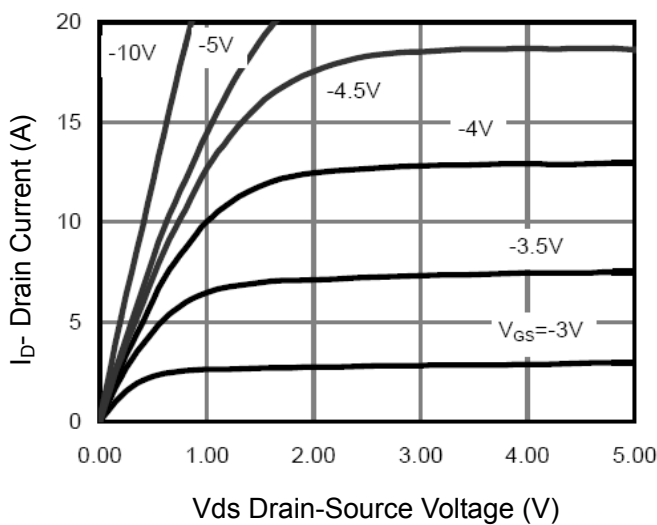

Figure 5 Output CHARACTERISTICS

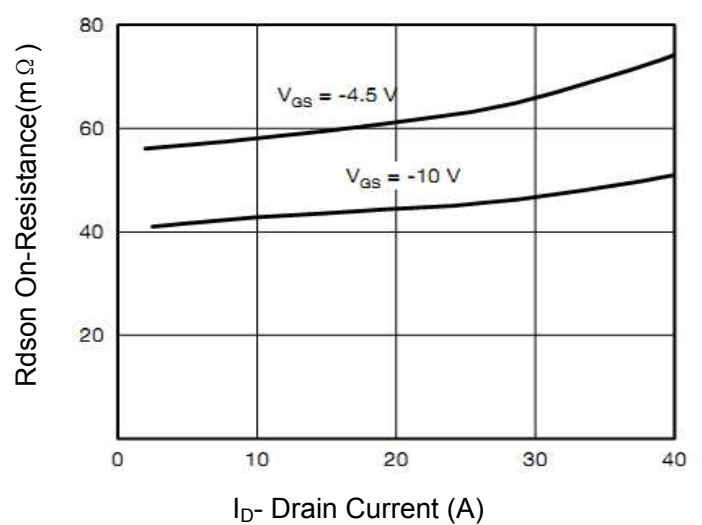
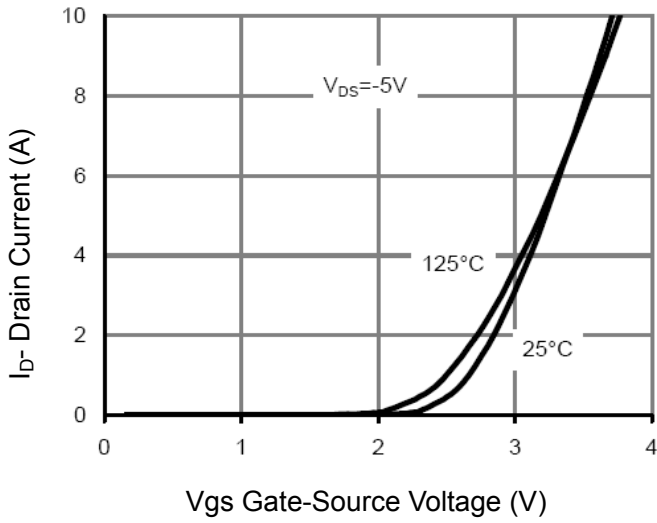
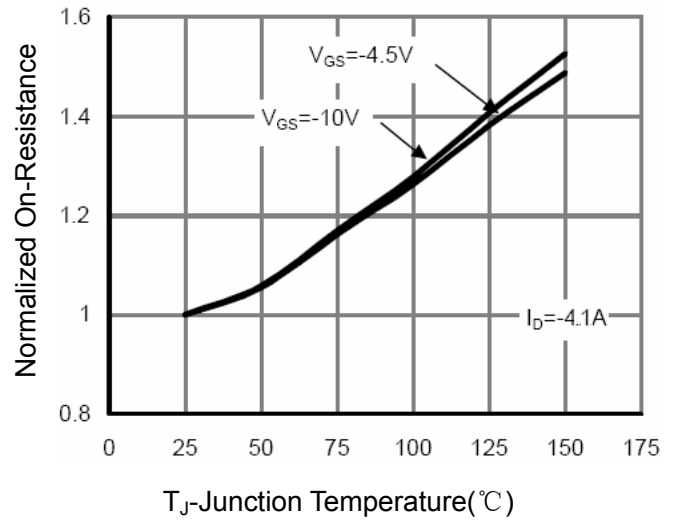

Figure 6 Drain-Source On-Resistance





Vgs Gate-Source Voltage (V)  
**Figure 7 Transfer Characteristics**



$T_J$ -Junction Temperature(°C)  
**Figure 8 Drain-Source On-Resistance**

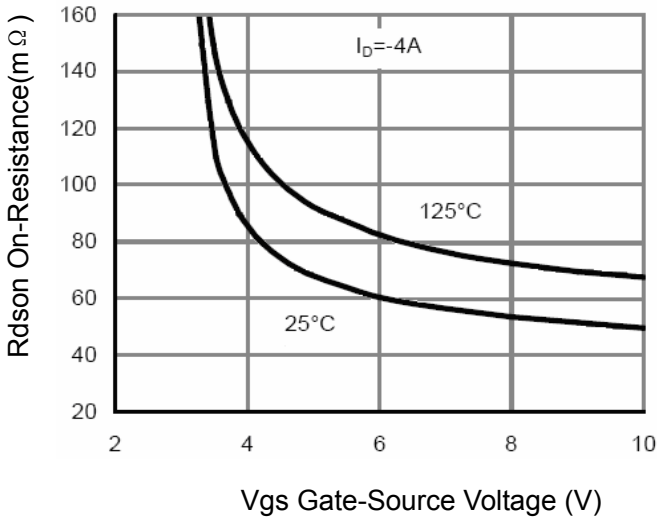

Vgs Gate-Source Voltage (V)  
**Figure 9 Rdson vs Vgs**

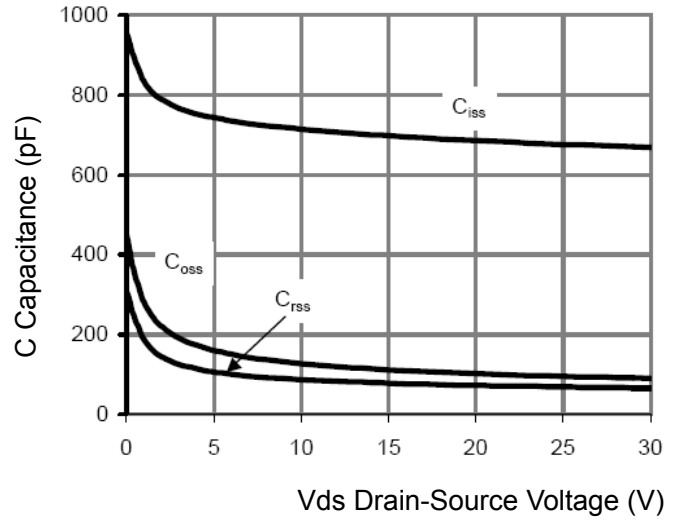

Vds Drain-Source Voltage (V)  
**Figure 10 Capacitance vs Vds**

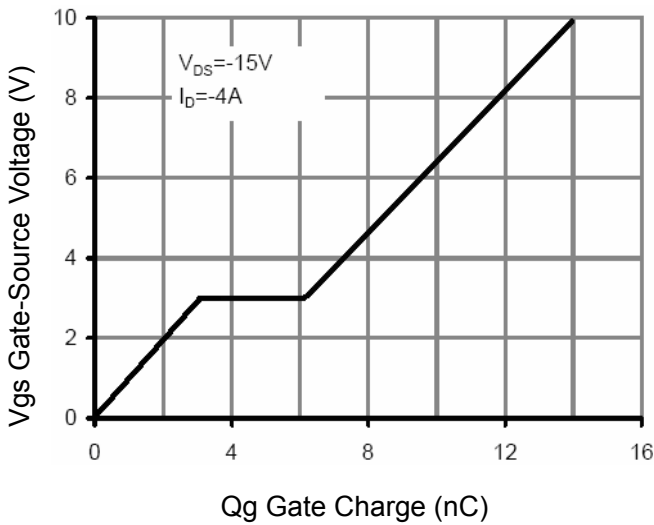

Qg Gate Charge (nC)  
**Figure 11 Gate Charge**

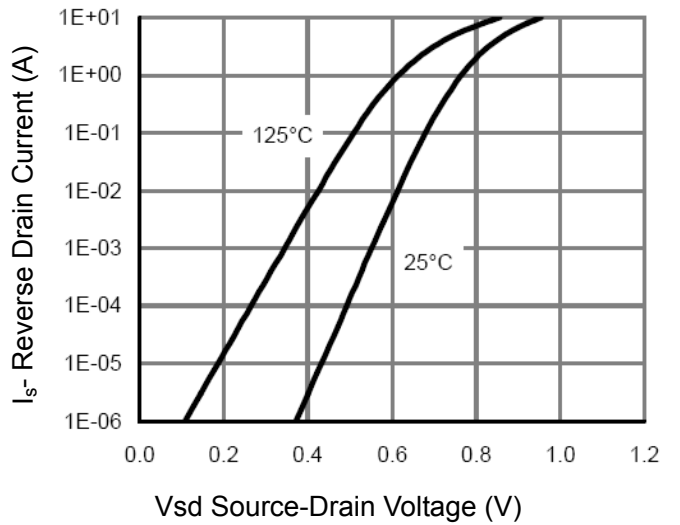

Vsd Source-Drain Voltage (V)  
**Figure 12 Source- Drain Diode Forward**



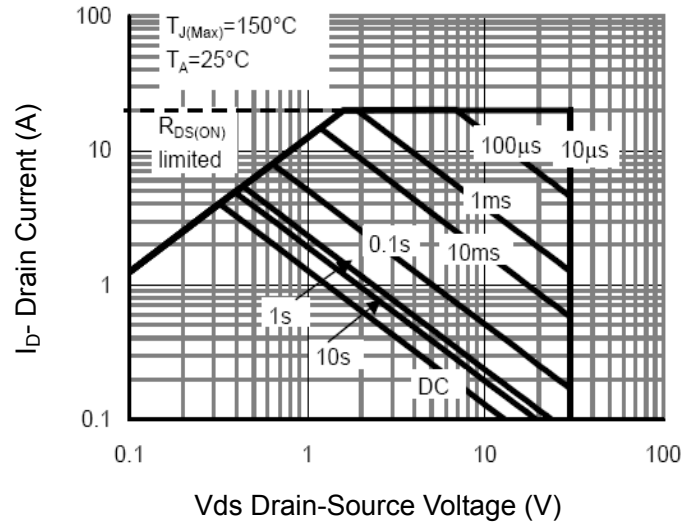

Figure 13 Safe Operation Area

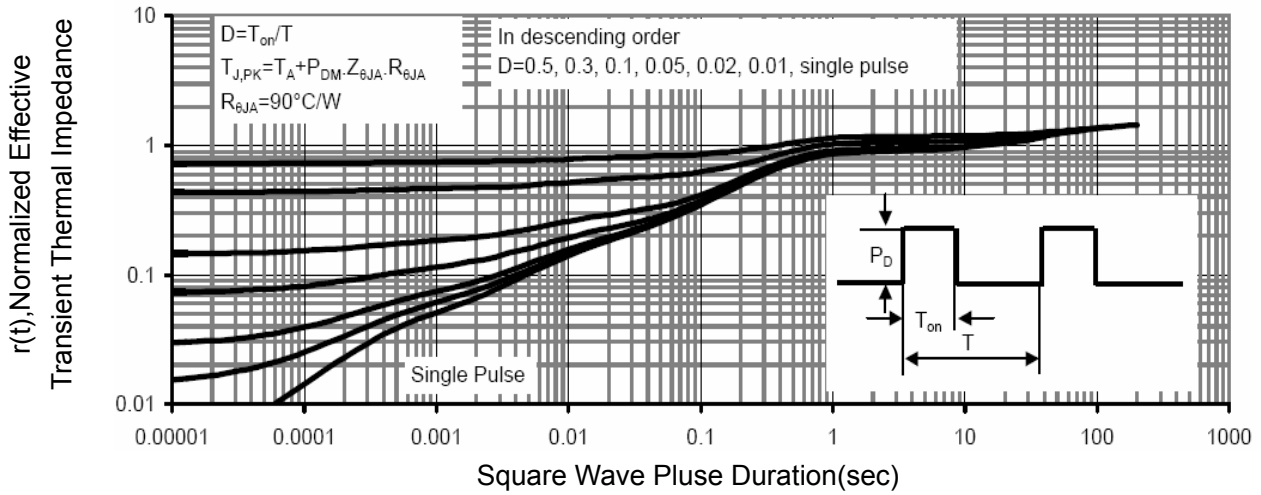
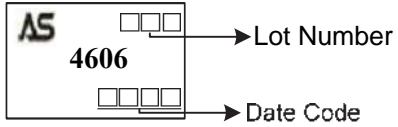

Figure 14 Normalized Maximum Transient Thermal Impedance

## Ordering and Marking Information

Ordering Device No.	Marking	Package	Packing	Quantity
ASDM4606S	4606	SOP-8	Tape&Reel	4000/Reel

PACKAGE	MARKING
SOP-8	 <p>AS      □□□□ → Lot Number 4606 □□□□ → Date Code</p>

## SOP-8 PACKAGE IN FORMATION

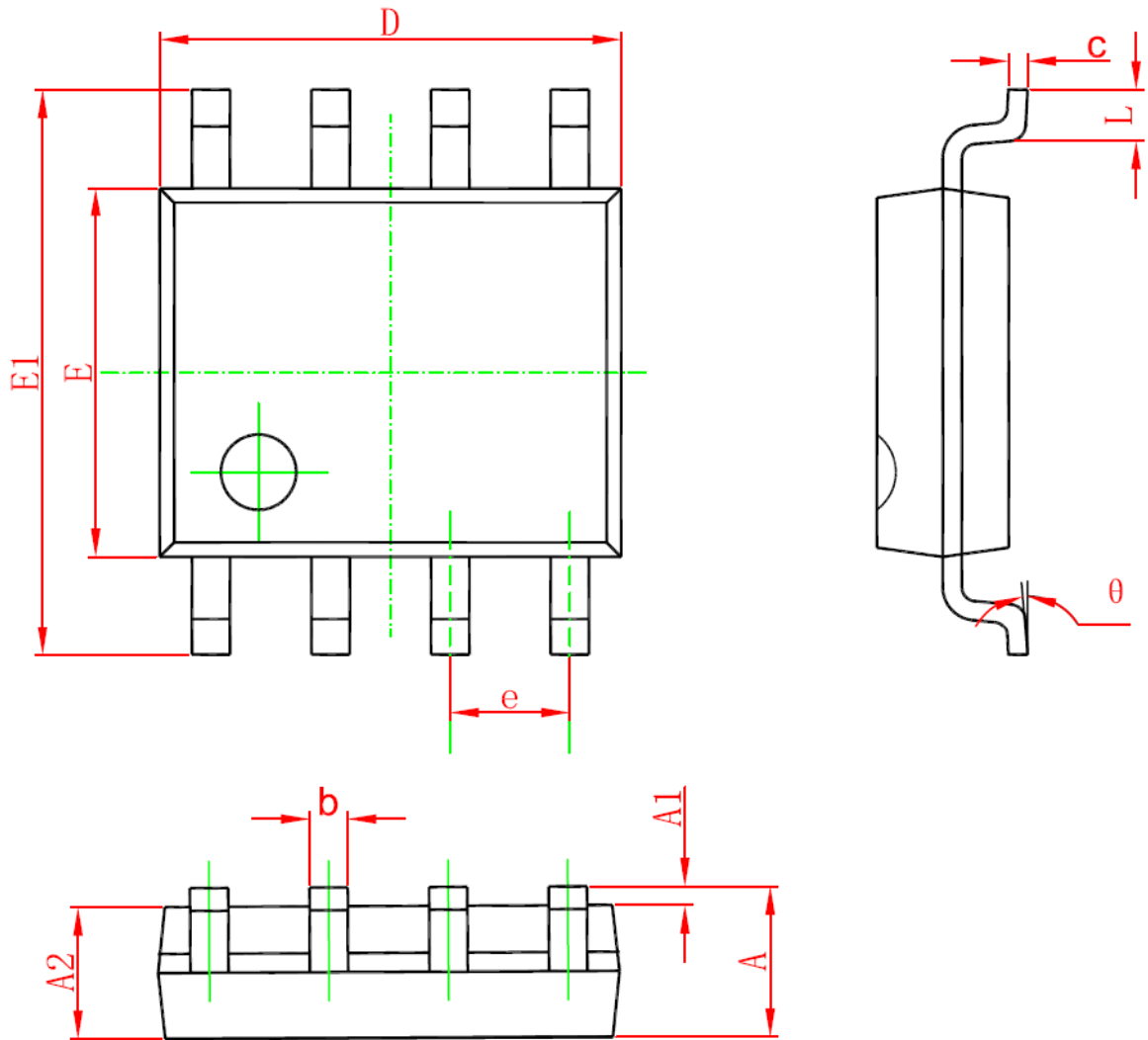

Symbol	Dimensions In Millimeters		Dimensions In Inches	
	Min	Max	Min	Max
A	1.350	1.750	0.053	0.069
A1	0.100	0.250	0.004	0.010
A2	1.350	1.550	0.053	0.061
b	0.330	0.510	0.013	0.020
c	0.170	0.250	0.006	0.010
D	4.700	5.100	0.185	0.200
E	3.800	4.000	0.150	0.157
E1	5.800	6.200	0.228	0.244
e	1.270 (BSC)		0.050 (BSC)	
L	0.400	1.270	0.016	0.050
θ	0°	8°	0°	8°

**IMPORTANT NOTICE**

ShenZhen Ascend Semiconductor incorporated MAKES NO WARRANTY OF ANY KIND, EXPRESS OR IMPLIED, WITH REGARDS TO THIS DOCUMENT, INCLUDING, BUT NOT LIMITED TO, THE IMPLIED WARRANTIES OF MERCHANTABILITY AND FITNESS FOR A PARTICULAR PURPOSE (AND THEIR EQUIVALENTS UNDER THE LAWS OF ANY JURISDICTION).

ShenZhen Ascend Semiconductor Incorporated and its subsidiaries reserve the right to make modifications, enhancements, improvements, corrections or other changes without further notice to this document and any product described herein. ShenZhen Ascend Semiconductor Incorporated does not assume any liability arising out of the application or use of this document or any product described herein; neither does ShenZhen Ascend Semiconductor Incorporated convey any license under its patent or trademark rights, nor the rights of others. Any Customer or user of this document or products described herein in such applications shall assume .

all risks of such use and will agree to hold Ascendsemi Incorporated and all the companies whose products are represented on ShenZhen Ascend Semiconductor Incorporated website, harmless against all damages.

ShenZhen Ascend Semiconductor Incorporated does not warrant or accept any liability whatsoever in respect of any products purchased through unauthorized sales channel. Should Customers purchase or use ShenZhen Ascend Semiconductor Incorporated products for any unintended or unauthorized application, Customers shall indemnify and hold ShenZhen Ascend Semiconductor Incorporated and its representatives harmless against all claims, damages, expenses, and attorney fees arising out of, directly or indirectly, any claim of personal injury or death associated with such unintended or unauthorized application.

[www.ascendsemi.com](http://www.ascendsemi.com)